



T H E

COUPÉ

4

THE NEW BMW 4 SERIES COUPÉ.



INNOVATION AND TECHNOLOGY.



18 Powertrain and suspension



20 Driver assistance
21 Safety



22 Connectivity and infotainment
23 Comfort and functionality

EQUIPMENT.



24 Models and Lines



32 Additional equipment

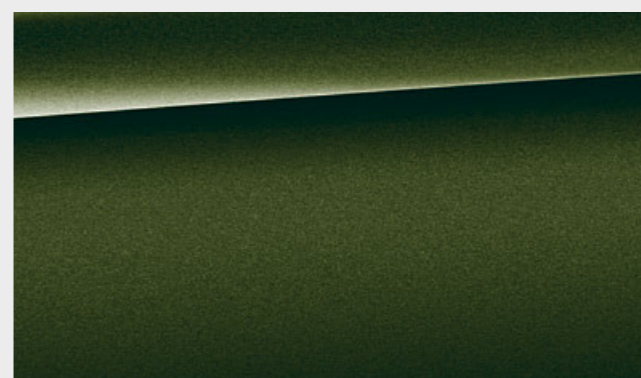

36 Exterior colours

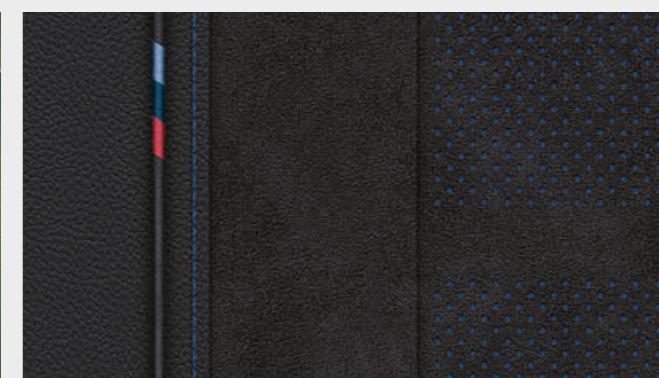

38 Interior colours

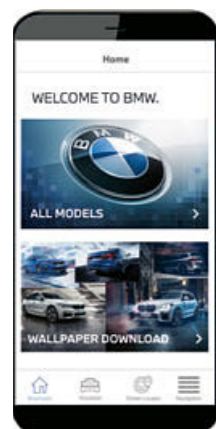

YOUR BMW BROCHURES APP.

DOWNLOAD NOW THE BMW BROCHURES APP FROM YOUR APP STORE AND DISCOVER DRIVING PLEASURE!



40 Wheels and tyres



41 Original BMW Accessories

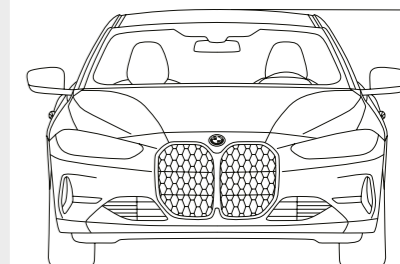

42 Technical data

TRUE DESIGN

ONLY POINTS IN ONE DIRECTION -

THE FUTURE.



EVEN
THE MOST EXCITING CAR
IS NOTHING
UNTIL EXPERIENCED.





IMITATION
IS INEVITABLE.

STYLE TEMPLATE OF STYLE TEMPLATES.





AN ICON IN A SEA

OF ORDINARY.





TRENDS FADE,



STYLE IS FOREVER.



ONLY THOSE WHO DO NOT WANT TO PLEASE
ALL THE TIME CAN INSPIRE EVERYONE.

THE NEW BMW 4 SERIES COUPÉ.



■ Standard equipment □ Optional equipment



ENGINE HIGHLIGHTS OF THE NEW BMW 4 SERIES COUPÉ.

M440i xDrive⁵ with mild hybrid technology
BMW TwinPower Turbo 6-cylinder petrol engine with 275 kW (374 hp) and 500 Nm torque (plus 8 kW (11 hp) with mild hybrid technology)
Acceleration 0–100 km/h: 4.5 s
Top speed: 250 km/h¹
Combined fuel consumption²: 6.8–7.1 l/100 km
Combined CO₂ emissions²: 155–163 g/km

430i
BMW TwinPower Turbo 4-cylinder petrol engine with 190 kW (258 hp) and 400 Nm torque
Acceleration 0–100 km/h: 5.8 s
Top speed: 250 km/h¹
Combined fuel consumption²: 5.7–6.1 l/100 km
Combined CO₂ emissions²: 131–141 g/km

■ For added traction, driving dynamics and safety, the **BMW xDrive all-wheel drive system*** provides variable drive power distribution to the front and rear axles.

□ The **variable sport steering*** including Servotronic continuously adjusts the steering effort required and steering force depending on the current speed and on the angle of the steering wheel.

□ The **Adaptive M suspension** with variable shock absorber adjustment offers the choice between comfortable and sporty suspension design.

□ The **M sport differential*** optimises traction and driving stability when driving dynamically or on different road surfaces.

¹ Electronically limited.

² The data for fuel consumption, CO₂ emissions and energy consumption are determined in accordance with the measurements processes as defined by European Regulation (EU) 2007/715 in the applicable version. Data refer to a vehicle with base-level equipment in Germany, and the ranges account for differences according to the

selected wheel and tyre size and the optional equipment and may change during the configuration process. Figures have been determined on the basis of the new WLTP test cycle and have been converted back into NEDC figures for comparability. [For these vehicles, values other than those specified here may apply for the assessment of taxes and other vehicle-related charges that are (also) based on CO₂ emissions.]

M SPORT BRAKES

□ The M Sport brake^{3,*} has four-piston fixed calipers at the front and single-piston floating calipers at the rear in Blue metallic with the M logo and features larger brake discs to ensure an outstanding braking performance. Adapted to the vehicle's very high dynamic potential, it also allows an exceptional athletic driving style and excellent braking on wet surfaces.

STANDARD SUSPENSION

■ The Standard suspension offers a high level of precision, agility and suspension comfort. This is made possible by a double-joint spring-strut front axle made of aluminium and an elaborately designed five-arm rear axle, along with the highly meticulous fine-tuning of all components.

MILD HYBRID TECHNOLOGY

□ Mild hybrid technology* saves fuel by recovering braking energy and supports the combustion engine during acceleration.

M TECHNOLOGY PACKAGE

□ The M Technology package⁴ includes an optimised cooling package and a reinforced M Sport brake, so that optimal performance is ensured, even in sporting use.

STEPTRONIC SPORT TRANSMISSION

□ The 8-speed Steptronic Sport transmission* offers incredibly sporty gear changes. Whether automatic or manual using gearshift paddles or selector lever.

M SPORT SUSPENSION

□ M Sport suspension is notable for a more dynamic suspension with tighter damper settings.



³ Only available for M440i xDrive and M Sport package.

⁴ Only available for M440i xDrive.

⁵ This engine version is not available in all countries. For further information, please contact your local BMW Partner.

* The availability of some equipment features and functions depends on engine variants or additional options. The market and production availability may vary. You can find detailed information about terms, standard and optional equipment at www.bmw.com or at your BMW Partner.

DRIVER ASSISTANCE.

□ **Driving Assistant Professional¹*** offers optimum comfort and safety during critical or monotonous traffic situations. Apart from the contents of the Driving Assistant, it also includes Steering and Lane Control Assistant with extended functions, Lane Change and Emergency Stop Assistant and Lane Keeping Assistant with active side collision protection.

□ **Active Cruise Control with Stop&Go function** maintains within a speed range of 30 to 160 km/h a pre-defined distance from the vehicle ahead, including stopping and restarting in stop-and-go traffic. Speed Limit Assist allows the takeover of speed limits in the cruise control. The front collision warning with brake intervention reacts to stationary vehicles, pedestrians and cyclists.

□ The **Steering and Lane Control Assistant with extended functions*** can be activated to support you in monotonous traffic situations. It helps you to keep the vehicle in the centre of its lane, assists you in narrow places and, with active route guidance, makes navigation on motorways easier.

□ **Parking Assistant Plus²*** makes parking and manoeuvring the vehicle easier. It features among others the Surround View system including Top View, Panorama View, Remote 3D View, as well as a lateral parking aid, the emergency braking function Active Park Distance Control, Parking Assistant with longitudinal and lateral guidance and Reversing Assistant.

□ The **Reversing Assistant*** stores the last 50 m of the driven path in forward travel up to 35 km/h, so that it can be retracted if required. You are relieved of the steering work and can concentrate on monitoring the vehicle environment.

□ The **Assisted Driving View*** provides real-time information on the vehicle surroundings collected by various assistance systems. Thanks to an animated 3D display in the instrument cluster, you can clearly see how your vehicle perceives the current traffic situation and thus understand how the systems work.



SAFETY.

■ Standard equipment □ Optional equipment

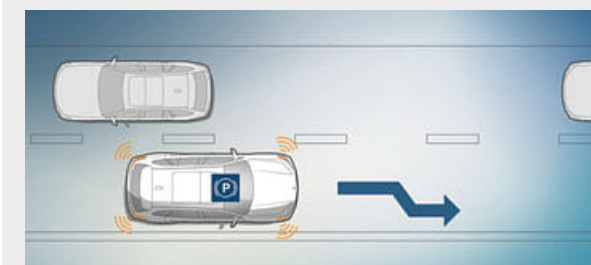

□ In the event of a medical emergency, the **Emergency Stop Assistant*** can drive the vehicle for a short period of time and bring it to a standstill.

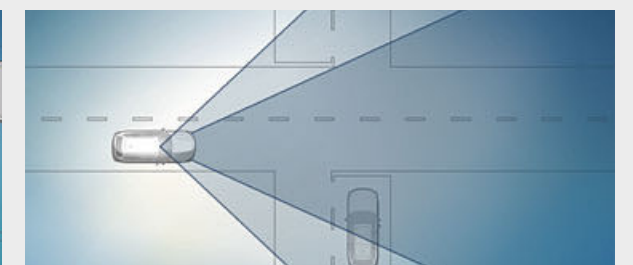

□ The **junction warning*** with brake intervention detects traffic lights, traffic signs and vehicles crossing and helps to avoid accidents.

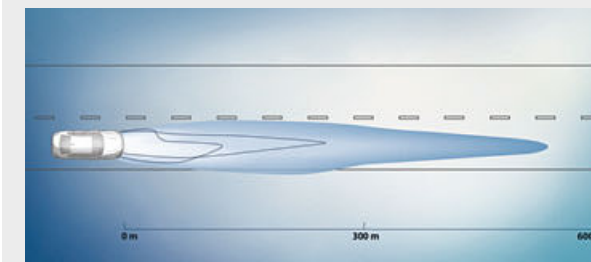

□ The Adaptive **BMW Laserlight*** extends the maximum illumination range in high-beam mode to up to 550 m.

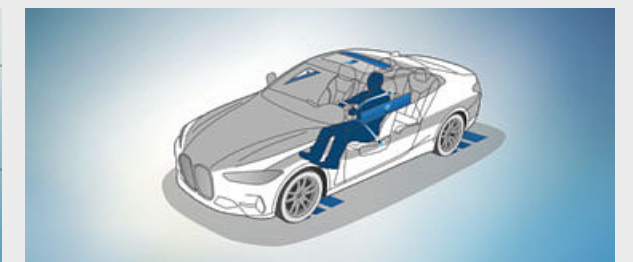

□ The preventive occupant protection **Active Protection*** takes precautions in critical situations.

¹ Function may be limited in darkness, fog or bright glare.

² The driver is responsible for constantly monitoring the automated parking procedure in accordance with local road laws.

*The availability of some equipment features and functions depends on engine variants or additional options. The market and production availability may vary. You can find detailed information about terms, standard and optional equipment at www.bmw.com or at your BMW Partner.

Some ConnectedDrive Services may differ between countries. Please consult your local BMW partner for more information.

CONNECTIVITY AND INFOTAINMENT.

BMW ConnectedDrive
So connected, you're free.



BMW LIVE COCKPIT PROFESSIONAL

□ BMW Live Cockpit Professional* includes two high-quality displays consisting of a 10.25" Control Display and a fully digital 12.3" instrument display.

SMARTPHONE INTEGRATION

□ With smartphone integration¹, your vehicle supports Apple CarPlay and Android Auto. This way, you can access your usual apps in the vehicle.

CONNECTED PACKAGE PROFESSIONAL

□ Prepared for everything: with the Connected Package Professional*, you can secure the most important services from BMW ConnectedDrive.

REAL TIME TRAFFIC INFORMATION

□ From traffic jams to roadworks. Real Time Traffic Information* will find you the quickest and best way to your destination.

BMW INTELLIGENT PERSONAL ASSISTANT

□ "Hey BMW. Who are you?" The BMW Intelligent Personal Assistant* is the soul of your BMW. It knows you and supports you in many situations.

BMW DIGITAL KEY

□ Your vehicle key? No need for that anymore. The Digital Key²,* exists on your smartphone, and you can share it with friends.

¹ Smartphone integration is permanently available in the vehicle. It includes Apple CarPlay and Android Auto. Android Auto linking is only possible in conjunction with a BMW Live Cockpit. Due to possible future technical developments (e.g. of mobile phones), the usability of the Apple CarPlay or Google Android Auto service cannot be guaranteed permanently. CarPlay is a trademark of Apple Inc. Android Auto is a trademark of Google LLC.

² Prerequisite is a BMW ConnectedDrive account and a compatible smartphone. For customers with a non-compatible smartphone, a high-quality Key Card is provided. More information about the BMW Digital Key, e.g. regarding the compatibility of your smartphone, is available at www.bmw.com/digitalkey

COMFORT AND FUNCTIONALITY.

■ Standard equipment □ Optional equipment

■ The **Sport seats** for driver and front passenger provide optimum lateral support with their raised side bolsters and manually adjustable thigh support. The fore-and-aft position and seat angle can be manually adjusted.

□ Even before the engine has reached its running temperature, the **seat heating for driver and front passenger** provides pleasant warmth, adjustable in three levels. The heat elements warm the surface of the seat, the side bolsters, and the entire contact surface of the backrest.

□ The **Comfort Access** makes it possible to open all of the vehicle doors and the luggage compartment, without using the key. When approaching, the welcome greeting is activated even before the doors unlock automatically. You can additionally set up a BMW Digital Key on an iPhone – if compatible – or use the Key Card for accessing and starting the vehicle.

□ **Automatic tailgate operation** allows the convenient opening and closing of the tailgate by simply pressing the button located in easy reach in the door panelling or on the vehicle key. The tailgate can also be opened in the conventional manner, using the outside handle, and closed pressing a button on the inside of the tailgate.

□ In warm weather, the front **active seat ventilation*** provides a cool and pleasant seat temperature, resulting in a more comfortable driving experience. Air vents in the seat surfaces and backrests blow air through the perforated seat covers. The intensity of the airflow is selected from three available settings.

□ The **Automatic air conditioning** with 3-zone control and automatic temperature control features separate controls for you and your front passenger, as well as for the passengers in the rear. It also includes Automatic Air Recirculation (AAR), a micro active carbon filter, a fog and solar sensor, as well as rear air vents with a digital display.



*The availability of some equipment features and functions depends on engine variants or additional options. The market and production availability may vary. You can find detailed information about terms, standard and optional equipment at www.bmw.com or at your BMW Partner.

Some ConnectedDrive Services may differ between countries. Please consult your local BMW partner for more information.

BASE.

Discover even more with the new BMW Brochures app. Available now, for your smartphone and tablet.

■ Standard equipment □ Optional equipment



■ The black Sport leather steering wheel with four spokes features a Pearl Chrome decorative trim. A thick rim and contoured thumb rests provide an exceptionally pleasant, high-grip feel.



■ The Sport seats for driver and front passenger provide optimum lateral support with their raised side bolsters and manually adjustable thigh support. The fore-and-aft position and seat angle can be manually adjusted.

Selected base model equipment features:

- 17" light alloy wheels V-spoke style 778
- Cloth/Sensatec combination
- Interior trim finishers Black high-gloss
- BMW Live Cockpit, 8.8" Control Display with touch function, analogue instrument cluster with 5.7" display
- Sport leather steering wheel
- Multifunction buttons on the steering wheel
- Automatic air conditioning
- Standard seat for driver and front passenger
- Floor mats in velour
- Steptronic transmission
- LED headlights



□ 18" light alloy wheels V-spoke style 780 Bicolour Orbit Grey, gloss-lathed, wheel size 7.5J x 18 with 225/45 R18 tyres.



□ 18" light alloy wheels Double-spoke style 782 Bicolour Jet Black uni, gloss-lathed, wheel size 7.5J x 18 with 225/45 R18 tyres.

M SPORT PACKAGE.



Discover even more with the new BMW Brochures app. Available now, for your smartphone and tablet.

■ Standard equipment □ Optional equipment



■ The M Leather steering wheel including multifunction buttons, an M badge and an integrated driver-side airbag is featured in three-spoke design. With a steering wheel rim in leather 'Walknappa' Black with black stitching and contoured thumb rests, it provides a direct, athletic steering experience.



□ The multi-adjustable M Sport seats* with bucket seat character and partly integrated headrest provide excellent lateral support for you and your front passenger. In addition, the backrest width can be individually adjusted. Their special design with black M logo highlights the vehicle's athletic capabilities.

M Sport package exterior equipment:

- M Aerodynamics package with front apron, side sills and rear apron in body colour with two-piece diffuser insert in Dark Shadow metallic and black high-gloss
- LED fog lights
- 18" M light alloy wheels Double-spoke style 848 M Bicolour Jet Black with mixed tyres; other wheels available
- M Sport brake with brake calipers in Dark Blue metallic and M designation, alternatively with brake calipers in Red high-gloss
- M Sport suspension incl. Variable sport steering; other suspensions available
- BMW Individual high-gloss Shadow Line, alternatively BMW Individual Exterior Line Aluminium satinised
- M designation on the sides
- Exterior mirror caps in body colour, alternatively in Black high-gloss*
- Roof trim strip in body colour
- Tailpipe trims in Chrome high-gloss, alternatively in Black high-gloss*
- Exclusive Portimao Blue metallic exterior colour; other exterior colours available

M Sport package interior equipment:

- M door sill finishers
- M driver footrest and M pedals
- Front floor mats with exclusive M designation
- Sport seats for the driver and front passenger in Alcantara/Sensatec combination with perforation and Blue contrast stitching; other upholsteries available
- M Leather steering wheel
- Vehicle key with exclusive M designation
- BMW Individual headliner anthracite
- Instrument cluster with M specific display
- Interior trim finishers in Aluminium Tetragon, other trims available



■ 18" M light alloy wheels Double-spoke style 848 M Bicolour Jet Black with mixed tyres, gloss-lathed, wheel size front 7.5J x 18 with 225/45 R18 tyres, wheel size rear 8.5J x 18 with 255/40 R18 tyres.



□ 19" M light alloy wheels Double-spoke style 797 M Bicolour Jet Black matt with mixed tyres and run-flat tyres, gloss-lathed, wheel size front 8J x 19 with 225/40 R19 tyres, wheel size rear 8.5J x 19 with 255/35 R19 tyres.



□ BMW Individual headliner anthracite: Headliner, parcel shelf and trims on the roof pillars feature Anthracite cloth.

BMW M440i xDRIVE COUPÉ.

You will feel, hear and see the difference: The new BMW M440i xDrive Coupé boasts a 275 kW (374 hp) BMW TwinPower Turbo 6-cylinder petrol engine. The specifically tuned M Sport suspension as well as the sensitive Variable sport steering guarantee absolute control thanks to a particularly precise steering and cornering performance. The design also sets highlights in terms of dynamics: From the vertical BMW kidney grille with mesh design to the double-flanged tailpipes, from the M leather steering wheel to the ergonomic Sport seats, numerous details add to the powerful character and spread a true racing feeling in everyday life.

■ Standard equipment □ Optional equipment



■ The M rear spoiler emphasises the vehicle's athletic silhouette and reduces unwanted aerodynamic uplift.



■ Aerodynamic components ensure an even sportier appearance. The M Aerodynamics package consists of a front and rear apron as well as the side skirts. The insert in the rear bumper panel is finished in black high-gloss.



■ The model designation of the new BMW M440i xDrive can be found on the right side of the tailgate and is designed in Cerium Grey.



□ The all-digital instrument cluster creates an adrenaline-loaded ambience in the cockpit with its exclusive "M440i" model designation, which is further enhanced by the compact M leather steering wheel with gearshift paddles.

BMW INDIVIDUAL.

THE EXPRESSION OF PERSONALITY.



The sporting and elegant character of the new BMW 4 Series Coupé is impressively underlined by the BMW Individual Dravite Grey metallic paint finish. The refinement of the dark grey basic colour with yellow Xirallic pigments creates a unique effect that is particularly visible in intense sunlight.



Only selected and flawless premium leather is used for the BMW Individual full leather trim 'Merino' Fiona Red/Black. An elaborate natural tanning process brings out the voluminous, breathable and durable character exceptionally well.



The interior trim finishers in BMW Individual fine-wood trim 'Fineline' black with silver effect open-pored round out the interior with their modern and particularly elegant look.

If someone decides, then you: BMW Individual offers you all the options to customise the new BMW 4 Series Coupé according to your wishes, with the degree of customisation entirely up to you. Add your personal driving experience to the typical BMW driving pleasure. Choose what suits you the most from particularly high-quality equipment options: exclusive BMW Individual paint finishes that show style and confidence. Soft, voluminous leather trims and interior trim finishers made of fine woods, which turn the interior into your personal comfort zone. Or go your very own way, only following your ideas – BMW Individual ensures that they become an automotive reality.

ADDITIONAL EQUIPMENT.

Discover even more with the new BMW Brochures app. Available now, for your smartphone and tablet.

■ Standard equipment □ Optional equipment



□ In laser high-beam mode, the Adaptive BMW Laserlight* illuminates a range of up to 550 m, nearly twice as far as that of conventional headlights. Better visibility in the dark significantly increases safety. Blue accents and the lettering "BMW Laser" in the headlight also underline the technological standards and the sportiness of the vehicle.



□ The M seat belts¹ with belt tensioner and belt force limiter boast an exquisite stitched highlight in the classic M colours.



□ The M Sport brake has four-piston fixed calipers at the front and single-piston floating calipers at the rear in Red high-gloss¹ * with M lettering and features larger brake discs to ensure an outstanding braking performance. Adapted to the vehicle's very high dynamic potential, it also allows an exceptional athletic driving style and excellent braking on wet surfaces.



□ The BMW Individual lights Shadow Line* include a black finish of all chrome elements in the headlights, creating an unmistakable design.



□ The M Carbon exterior package¹ underlines the athletic demands of the vehicle. Side spoiler elements in the front bumper and exterior mirror caps are made of carbon-fibre reinforced plastic (CFRP). The package is rounded off by a diffuser insert at the rear and a rear spoiler in specific geometry.



□ The BMW Live Cockpit Plus with navigation function includes an instrument panel with a 5.1" instrument cluster, a high-resolution 8.8" touch-enabled Control Display and the iDrive Touch Controller on the centre console. The BMW Operating System 7 can also be operated via the iDrive Controller.



□ The M Leather steering wheel including multifunction buttons, an M badge and an integrated driver-side airbag is featured in three-spoke design. With a steering wheel rim in leather 'Walknappa' Black with black stitching and contoured thumb rests, it provides a direct, athletic steering experience.



□ The mirror caps are painted in Black* high-gloss instead of the body colour. They emphasise the vehicle's athletic look and create an individual appearance.



□ BMW Individual high-gloss Shadow Line includes numerous equipment details in Black high-gloss. These include the window recess cover, the window surrounds, the exterior mirror frame, the mirror triangle and blade.



□ The glass sunroof with slide and lift function, including an electric sliding interior roof, anti-trap protection, as well as comfort opening and closing, allows the airflow to be individually regulated to create a pleasant interior climate. The integrated wind deflector prevents draughts from developing in the interior and ensures a lower level of wind noise.



□ Ambient light, including Ambient contour lighting in the doors, creates a relaxed, cosy lighting atmosphere in the interior. The eleven dimmable lighting designs also include a dynamic function in four applications. The Welcome Light Carpet illuminates the area in front of the vehicle doors when entering and exiting.

*The availability of some equipment features and functions depends on engine variants or additional options. The market and production availability may vary. You can find detailed information about terms, standard and optional equipment at www.bmw.com or at your BMW Partner.

¹ Only available for M440i xDrive and M Sport package.

ADDITIONAL EQUIPMENT.

Discover even more with the new BMW Brochures app. Available now, for your smartphone and tablet.

■ Standard equipment □ Optional equipment



□ The large full-colour BMW Head-Up Display¹* projects information relevant to the journey directly into your field of vision, thereby allowing you to fully concentrate on driving. Information such as the current speed, navigation directions, Speed Limit Info including no-overtaking indicator, along with telephone and entertainment lists are displayed, depending on the equipment.



□ Telephony with wireless charging³ incorporates a wireless charging dock and a second microphone for a better hands-free voice quality for you and your front passenger. A roof aerial connection improves mobile reception. Two mobile telephones and an audio player can be connected simultaneously via Bluetooth. Also included is the technical capacity for a Wi-Fi hotspot.



□ Contactless opening and closing of the tailgate* is part of the Comfort access system. In situations where the user's hands are full, all that's necessary is a targeted motion of the foot under the rear bumper and the process is carried out conveniently and automatically. They just need to be carrying the vehicle key with them.



□ The safety package Driving Assistant²* includes the camera-based systems front collision warning with braking function, Speed Limit Assist incl. Speed Limit Info with no-overtaking indicator and pre-warning as well as Lane Departure Warning. Additionally, the radar-based equipment includes rear crossing traffic warning, Lane Change Warning and rear collision warning.

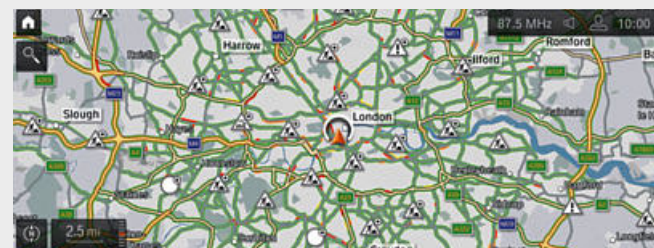

□ BMW Maps – Connected Navigation* impresses with high accuracy of the predicted arrival time, extremely fast route calculation and simplified destination entry. This is possible through free text input. The cloud-based dynamic route calculation immediately adapts the route recommendation to any changes in the traffic situation.



□ The Parking Assistant⁴* parks the vehicle independently in cross and longitudinal parking spaces as well as out of longitudinal parking spaces. It is accessed via the parking button or by engaging reverse gear. All steering, driving and braking processes are taken over by the system, you only have to monitor the parking process.



□ Surround View* includes the camera-based functions Top View, Panorama View and 3D View. Cameras at the front, at the rear and in the exterior mirrors allow a 360° view to be shown on the Control Display, as well as an overhead view. Panorama View makes it easier to approach intersections and driveways with low visibility.



□ The tonally outstanding Harman Kardon surround sound system features a 464 W digital amplifier, nine channels and 16 speakers. Its sophisticated sound perfectly fills the interior space. Vehicle-specific, speed-dependent equalising precisely compensates for any background driving noise.



□ Do you want your BMW to be up to date with the latest software? With Remote Software Upgrade*, your BMW will always be up to date. Upgrades are installed over the air, just as they are for your smartphone. In this way, other functions in your vehicle can also be activated.



□ With BMW Gesture Control*, certain functions can be operated by means of defined hand movements. For certain operations the system will for example recognise gestures such as 'swiping' or 'pointing' for accepting or rejecting an incoming call, or circular motions of the index finger to adjust volume.



□ The Adaptive M suspension can be electrically adjusted at any time to suit the road and driving conditions. You can also adjust the suspension characteristics via the Driving Experience Control to enable your preferred driving style at the time – from comfortable to extremely athletic with markedly agile handling.

¹ The information in the BMW Head-Up Display is not fully visible when viewed through polarised sunglasses. Content shown will depend on the equipment options chosen. Further optional equipment is required to display specific items.
² Function may be limited in darkness, fog or bright glare.

³ Supports inductive charging for Qi-compatible mobile phones. Special charging cases are available from Original BMW Accessories for selected smartphones that do not support the Qi standard for inductive charging.

⁴ The driver is responsible for constantly monitoring the automated parking procedure in accordance with local road laws.
* The availability of some equipment features and functions depends on engine variants or additional options. The market and production availability may vary.

You can find detailed information about terms, standard and optional equipment at www.bmw.com or at your BMW Partner. Some ConnectedDrive Services may differ between countries. Please consult your local BMW partner for more information.

EXTERIOR COLOURS.

Discover even more with the new BMW Brochures app. Available now, for your smartphone and tablet.

■ Standard equipment □ Optional equipment



□ Non-metallic 300 Alpine White¹

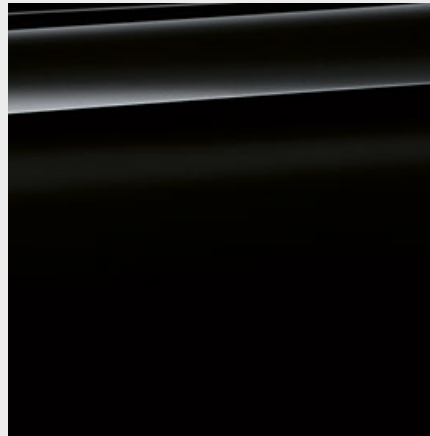

■ Non-metallic 668 Black



□ Metallic A96 Mineral White²



□ Metallic C2Y Bluestone

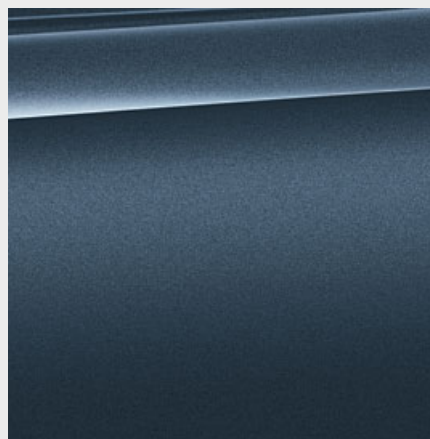

□ Metallic C4F Arctic Race Blue²



□ Metallic C31 Portimao Blue³

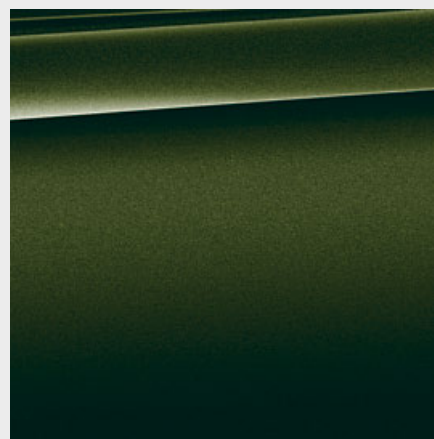

□ Metallic C4E Sanremo Green^{2,4}



□ Metallic C1X Sunset Orange

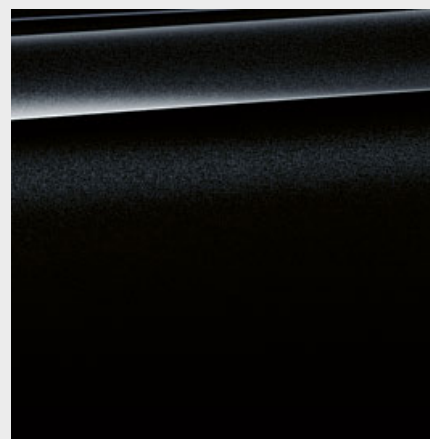

□ Metallic 475 Black Sapphire²

BMW INDIVIDUAL



□ BMW Individual special paintwork Brilliant White metallic^{2,5}

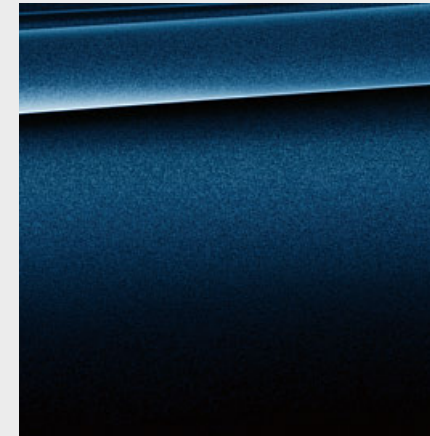

□ BMW Individual C3Z Tanzanite Blue metallic²

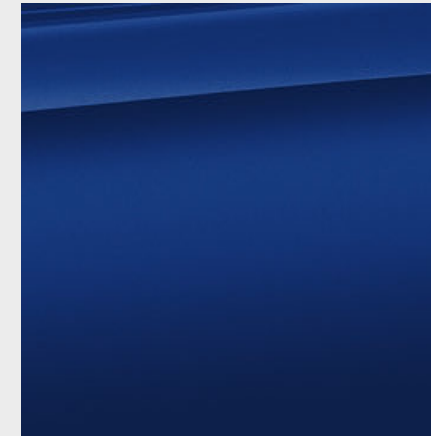

□ BMW Individual special paintwork Frozen Portimao Blue metallic^{2,5}



□ BMW Individual special paintwork Frozen Deep Grey metallic^{2,5}

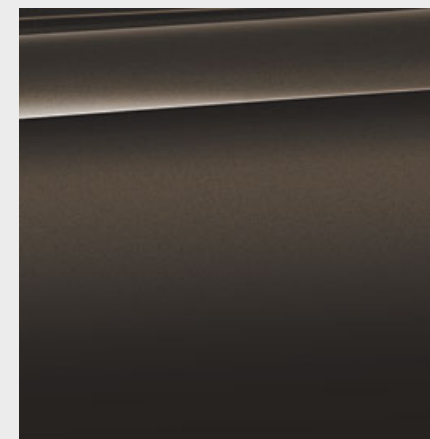

□ BMW Individual C36 Dravite Grey metallic²

[Colour samples] These colour samples are intended as an initial guide to the colours and materials available for your BMW. However, experience has shown that printed versions of paint, upholstery and interior trim colours cannot in all cases faithfully reproduce the appearance of the original colour. Please discuss your preferred colour choices with your BMW partner or dealership. There you can also see original samples and be assisted with special requests.

¹ Available as standard for M440i xDrive and M Sport package.

² Also optionally available for M440i xDrive and M Sport package.

³ Exclusively available for M440i xDrive and M Sport package.

⁴ Available from 11/20.

⁵ Available from 03/21.

The availability of some equipment features and functions depends on engine variants or additional options. The market and production availability may vary. You can find detailed information about terms, standard and optional equipment at www.bmw.com or at your BMW Partner.

INTERIOR COLOURS.

Discover even more with the new BMW Brochures app. Available now, for your smartphone and tablet.

■ Standard equipment □ Optional equipment

SENSATEC

Available with

- **Base model** Sensatec KCCY Canberra Beige
- **Base model** Sensatec KCFY Canberra Beige, interior colour Black
- **Base model** Sensatec KCSW Black

LEATHER

Available with

- **Base model** □ **M Sport package** Leather 'Vernasca' MAFO Canberra Beige with decorative stitching, interior colour Black
- **Base model** □ **M Sport package** Leather 'Vernasca' MAFX Canberra Beige with decorative stitching
- **Base model** □ **M Sport package** Leather 'Vernasca' MAOI Oyster with decorative stitching, interior colour Black
- **Base model** □ **M Sport package** Leather 'Vernasca' MAPQ Cognac with decorative stitching, interior colour Black

BMW INDIVIDUAL LEATHER

Available with

- **Base model** □ **M Sport package** BMW Individual extended leather trim 'Merino' VAEW Ivory White, interior colour Black¹
- **Base model** □ **M Sport package** BMW Individual full leather trim 'Merino' VBEW Ivory White, interior colour Black¹
- **Base model** □ **M Sport package** BMW Individual extended leather trim 'Merino' VATQ Tartufo, interior colour Black¹
- **Base model** □ **M Sport package** BMW Individual full leather trim 'Merino' VBTQ Tartufo, interior colour Black¹

INTERIOR TRIM FINISHERS

Available with

- **Base model** Interior trim finishers Black high-gloss with highlight trim finisher in Pearl Chrome
- **M Sport package** Interior trim finishers Aluminium Tetragon with highlight trim finisher in Pearl Chrome
- **Base model** □ **M Sport package** Interior trim finishers Aluminium 'Mesheffect' with highlight trim finisher in Pearl Chrome
- **Base model** □ **M Sport package** Interior trim finishers in fine-wood trim maple open-pored with highlight trim finisher Pearl Chrome
- **Base model** □ **M Sport package** Interior trim finishers in fine-wood trim oak grain open-pored with highlight trim finisher Pearl Chrome
- **Base model** □ **M Sport package** Interior trim finishers in fine-wood trim Ash grey-brown high-gloss with highlight trim finisher Pearl Chrome

CLOTH-SENSATEC COMBINATION

Available with

- **Base model** Cloth/Sensatec combination KFSW Black

Leather 'Vernasca' MAG6 Tacora Red with decorative stitching, interior colour Black

□ **Base model** □ **M Sport package**

Leather 'Vernasca' MAMU Mocha with decorative stitching, interior colour Black

□ **Base model** □ **M Sport package**

□ **Base model** □ **M Sport package** BMW Individual extended leather trim 'Merino' VAHZ Fiona Red/Black, interior colour Black¹

□ **Base model** □ **M Sport package** BMW Individual full leather trim 'Merino' VBHZ Fiona Red/Black, interior colour Black¹

ALCANTARA-SENSATEC COMBINATION

Available with

- **M Sport package** Alcantara/Sensatec combination KGNL Black with perforation, accent Blue

□ **M Sport package** Leather 'Vernasca' MANL Black, contrast stitching Blue, interior colour Black*

□ **Base model** □ **M Sport package** Leather 'Vernasca' MAH7 Black decor stitching, interior colour Black

□ **Base model** □ **M Sport package** BMW Individual extended leather trim 'Merino' ZAFV Fjord Blue/Black, interior colour Black¹

□ **Base model** □ **M Sport package** BMW Individual full leather trim 'Merino' ZBFV Fjord Blue/Black, interior colour Black¹

□ **Base model** □ **M Sport package** BMW Individual extended leather trim 'Merino' ZASW Black, interior colour Black¹

□ **Base model** □ **M Sport package** BMW Individual full leather trim 'Merino' ZBSW Black, interior colour Black¹

BMW INDIVIDUAL INTERIOR TRIM FINISHERS

Available with

- **Base model** □ **M Sport package** BMW Individual fine-wood trim 'Fineline' Black with silver effect open-pored and highlight trim finisher in Pearl Chrome
- **Base model** □ **M Sport package** BMW Individual interior trim finishers Aluminium fabric high-gloss with highlight trim finisher in Pearl Chrome
- **Base model** □ **M Sport package** BMW Individual interior trim finishers piano finish Black with highlight trim finisher Pearl Chrome

¹ Available from 03/21.

*The availability of some equipment features and functions depends on engine variants or additional options. The market and production availability may vary. You can find detailed information about terms, standard and optional equipment at www.bmw.com or at your BMW Partner.

Please note that even normal long- or short-term use can lead to unrecoverable upholstery damage. This can be caused in particular by non-colourfast clothing. Please note that the interior colour depends on the selected upholstery colour.

WHEELS AND TYRES.

Discover even more with the new BMW Brochures app. Available now, for your smartphone and tablet.



■ 17" light alloy wheels V-spoke style 778 Reflex Silver, wheel size 7.5J x 17 with 225/50 R17 tyres.



□ 18" light alloy wheels V-spoke style 780 Bicolour Orbit Grey, gloss-lathed, wheel size 7.5J x 18 with 225/45 R18 tyres.



□ 18" light alloy wheels Double-spoke style 782 Bicolour Jet Black uni, gloss-lathed, wheel size 7.5J x 18 with 225/45 R18 tyres.



□ 18" M light alloy wheels Double-spoke style 848 M Bicolour Jet Black with mixed tyres, gloss-lathed, wheel size front 7.5J x 18 with 225/45 R18 tyres, wheel size rear 8.5J x 18 with 255/40 R18 tyres.^{1,2}



□ 19" light alloy wheels Y-spoke style 783 Bicolour Jet Black with mixed tyres and run-flat tyres, gloss-lathed, wheel size front 8J x 19 with 225/40 R19 tyres, wheel size rear 8.5J x 19 with 255/35 R19 tyres.



□ 19" M light alloy wheels Double-spoke style 791 M Jet Black uni with mixed tyres and run-flat tyres, wheel size front 8J x 19 with 225/40 R19 tyres, wheel size rear 8.5J x 19 with 255/35 R19 tyres.¹



□ 19" M light alloy wheels Double-spoke style 792 M Bicolour Cerium Grey with mixed tyres and run-flat tyres, gloss-lathed, wheel size front 8J x 19 with 225/40 R19 tyres, wheel size rear 8.5J x 19 with 255/35 R19 tyres.³



□ 19" BMW Individual light alloy wheels Double-spoke style 793 I Bicolour Orbit Grey with mixed tyres and run-flat tyres, gloss-lathed, wheel size front 8J x 19 with 225/40 R19 tyres, wheel size rear 8.5J x 19 with 255/35 R19 tyres.



□ 19" M light alloy wheels Double-spoke style 797 M Bicolour Jet Black matt with mixed tyres and run-flat tyres, gloss-lathed, wheel size front 8J x 19 with 225/40 R19 tyres, wheel size rear 8.5J x 19 with 255/35 R19 tyres.¹

¹ Only available for M440i xDrive and M Sport package.
² Available as standard for M440i xDrive and M Sport package.
³ Only available for M440i xDrive.

The availability of some equipment features and functions depends on engine variants or additional options. The market and production availability may vary. You can find detailed information about terms, standard and optional equipment at www.bmw.com or at your BMW Partner.

ORIGINAL BMW ACCESSORIES.

■ Standard equipment □ Optional equipment ○ Accessories



○ Make a strong statement: the M Performance front splitter made of carbon fibre highlights the vehicle's masculine appearance in a highly exclusive manner. A unique motorsport look for anybody who refuses to compromise.



○ The lockable BMW ski and snowboard carrier that can be extended on the sides provides secure hold for up to five pairs of skis or snowboards and makes it easier to load higher vehicles. It can be combined with any BMW roof rack and also holds ski poles.



○ Gripping facts: Thanks to its Alcantara-lined grip area the M Performance steering wheel provides excellent feel and grip – for a sportier steering feel. Its distinctive design and centre band made of red leather underscore its motorsport style.



○ Wireless charging, any time and anywhere: Thanks to the BMW wireless charging station universal the smartphone can be charged comfortably and efficiently without a cable in the vehicle. The mobile phone is saved in a stable and safe way. Especially smart: The integrated powerbank can be removed and enables wireless charging outside the vehicle.

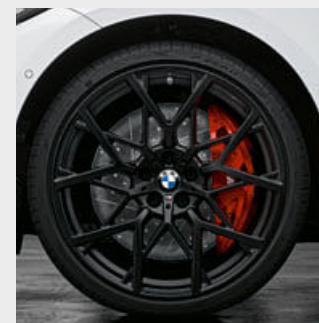

○ High-quality 20" M Performance forged wheels Y-spoke style 795 M in Jet Black matt. TPMS summer complete wheel set with run-flat tyres.

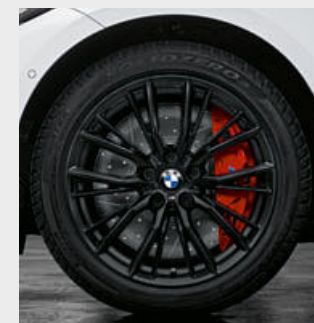

○ High-quality 18" M Performance light alloy wheels Double-spoke style 796 M in Jet Black matt. TPMS summer complete wheel set with run-flat tyres.



○ The M Performance side skirt extension made of carbon fibre visually lengthens the proportions of the vehicle, lending it an even more dynamic appearance.

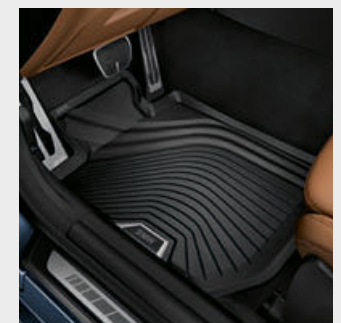

○ Precisely fitted protection against moisture and dirt in the front footwell. Featuring a black design with a stainless steel inlay, they perfectly complement the interior.

Discover the wide range of innovative solutions available for the exterior and interior, communication and information, and for transportation and the luggage compartment. Your BMW Partner is on hand to advise you on the whole range of

Original BMW Accessories and the BMW M Performance Parts product portfolio. For further information, please visit www.bmw.com

BMW 4 Series Coupé		420i	430i	M440i xDrive ⁶ with mild hybrid technology	420d ⁶ 420d xDrive ⁶ with mild hybrid technology
--------------------	--	------	------	---	---

Weight					
Unladen weight EU (xDrive) ¹	kg	1600	1620	(1815)	1680 (1745)
Max. permissible weight (xDrive)	kg	2015	2030	(2245)	2095 (2165)
Permitted load (xDrive)	kg	490	485	(505)	490 (495)
Permitted trailer load, unbraked (xDrive) ²	kg	750	750	(750)	750 (750)
Permitted trailer load, braked, max. 12% gradient/max. 8% gradient (xDrive) ²	kg	1600/1600	1600/1600	(1800/1800)	1600/1600 (1800/1800)
Luggage capacity	l	440	440	440	440

BMW TwinPower Turbo engine ³					
Cylinders/valves	-	4/4	4/4	6/4	4/4
Capacity	cm ³	1998	1998	2998	1995
Max. output/engine speed	kW (hp)/ rpm	135 (184)/5000–6500	190 (258)/5000–6500	275 (374)/5500–6500	140 (190)/4000
With mild hybrid technology	kW (hp)	-	-	+8 (11)	+8 (11)
Max. torque/engine speed	Nm/ rpm	300/1350–4000	400/1550–4400	500/1900–5000	400/1750–2500

Power transmission					
Type of drive (xDrive)	-	Rear-wheel	Rear-wheel	(all-wheel)	Rear-wheel (all-wheel)
Standard transmission (xDrive)	-	8-speed Steptronic	8-speed Steptronic	(8-speed Steptronic Sport)	8-speed Steptronic (8-speed Steptronic)

Driving performance					
Top speed (xDrive)	km/h	240	250 ⁵	(250) ⁵	240 (238)
Acceleration 0–100 km/h (xDrive)	s	7.5	5.8	(4.5)	7.1 (7.4)

Consumption ^{3,4} – All engines conform to the EU6 standard					
Urban (xDrive)	l/100 km	6.6–7.2	7.3–7.7	(8.6–9.0)	4.5–4.9 (4.8–5.2)
Extra-urban (xDrive)	l/100 km	4.6–5.0	4.8–5.3	(5.7–6.0)	3.6–3.9 (4.0–4.2)
Combined (xDrive)	l/100 km	5.3–5.8	5.7–6.1	(6.8–7.1)	3.9–4.2 (4.3–4.6)
Exhaust emissions standard (type-certified)	-	EU6d	EU6d	EU6d	EU6d
Combined CO ₂ emissions (xDrive)	g/km	122–132	131–141	(155–163)	103–112 (112–121)
Tank capacity, approx.	l	59	59	59	59

Wheels/tyres					
Tyre size (xDrive)		225/50 R17 Y	225/50 R17 Y	(225/45 R18 Y, 255/40 R18 Y)	225/50 R17 Y (225/50 R17 Y)
Wheel size (xDrive)		7.5 J x 17	7.5 J x 17	(7.5 J x 18, 8.5 J x 18)	7.5 J x 17 (7.5 J x 17)
Material		Light alloy	Light alloy	Light alloy	Light alloy

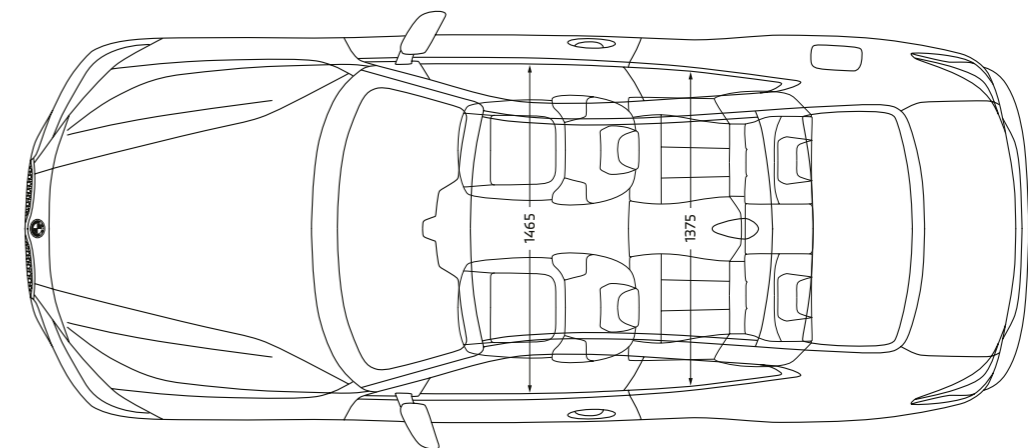
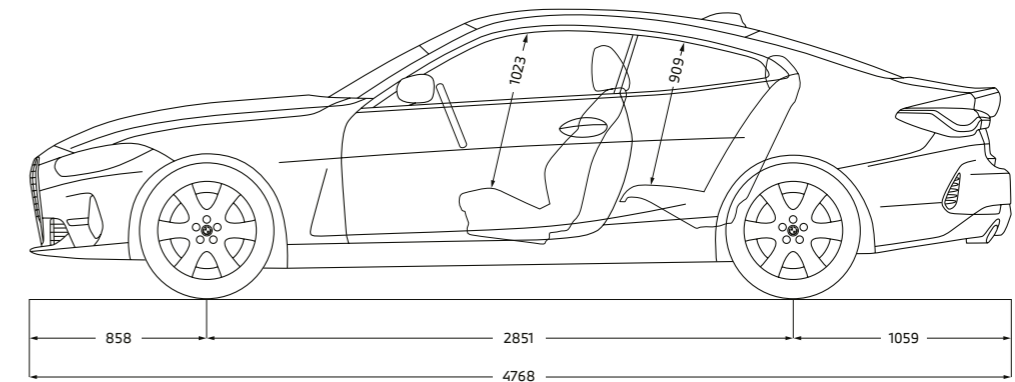
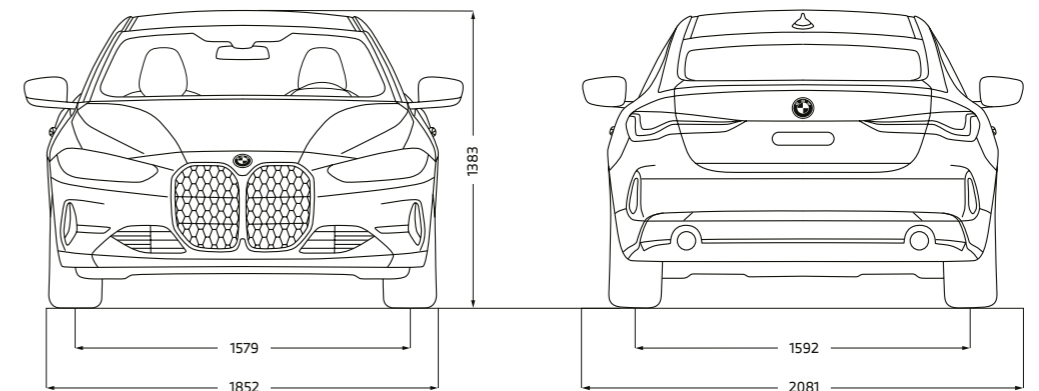

All dimensions in the technical drawing are given in millimetres. The dimensions for M440i xDrive may vary.

The figures for performance, fuel consumption and CO₂ emissions refer to vehicles with standard transmission.

¹ The EC unladen weight refers to a vehicle with standard equipment and does not include any optional extras. The unladen weight includes a 90% full tank and a driver weight of 75 kg. Optional equipment may affect the weight of the vehicle, the payload and the top speed if the selected equipment has an impact on the vehicle's aerodynamics.

² The actual total weight of the trailer must not exceed the maximum trailer load, taking into account the maximum tow bar download.

³ Performance data of petrol engines apply to vehicles using RON 98 fuel. Fuel consumption data apply to vehicles using reference fuels in accordance with EU Regulation 2007/715. Unleaded RON 91 and higher with a maximum ethanol content of 10% (E10) may also be used. BMW recommends RON 95 super unleaded petrol.

⁴ The data for fuel consumption, CO₂ emissions and energy consumption are determined in accordance with the measurements processes as defined by European Regulation (EU) 2007/715 in the applicable version. Data refer to a vehicle with base-level equipment in Germany, and the ranges account for differences according to the selected wheel and tyre size and the optional equipment and may change during the configuration process. Figures have been determined on the basis of the new WLTP test cycle and have been converted back into NEDC figures for comparability. [For these vehicles, values other than those specified here may apply for the assessment of taxes and other vehicle-related charges that are (also) based on CO₂ emissions.]

⁵ Electronically limited.

⁶ This engine version is not available in all countries. For further information, please contact your local BMW Partner.



YOUR BMW BROCHURES APP.

DOWNLOAD NOW THE BMW BROCHURES APP FROM YOUR APP STORE AND DISCOVER DRIVING PLEASURE!

BMW M440i xDRIVE:

BMW TwinPower Turbo 6-cylinder petrol engine, 275 kW (374 hp), 19" M light alloy wheels Double-spoke style 797 M Bicolour, exterior colour in Arctic Race Blue metallic, BMW Laserlight, Instrument panel in Sensatec, Sport seats in leather 'Vernasca' Cognac with decorative stitching, BMW Individual interior trim finishers Aluminium fabric high-gloss.

The models illustrated in this medium show the equipment and configuration options (standard and optional) for vehicles produced by BMW AG for the German market. Alterations in standard and optional equipment and the configurations available for the different models may occur after 04/29/2020, the editorial deadline for this medium, or according to the specific requirements of other markets. Your local BMW Partner is available to provide further details. Subject to change in design and equipment.

Of course, each vehicle is designed for economical recycling after its long-running life. You can find more information regarding your end-of-life vehicle on our website www.bmw.de/recycling.

© BMW AG, Munich, Germany. Not to be reproduced wholly or in part without prior written permission of BMW AG, Munich.